

SCADENZA 31 DICEMBRE 2023



05
C66

hall
stand

www.gerardi.it



ITALIANO

OFFERTA SPECIALE

EMO 2023

TESTE ANGOLARI
Classic Line

MOTORIZZATI
Per Torni & Torrette

DISPONIBILE A BREVE IL NUOVO

STOZZATORE MODULARE

Potenzia ed Aggiorna il tuo Torno!

Realizza Scanalature e Cave
Interne direttamente Sul Torno



Go to the Brochure

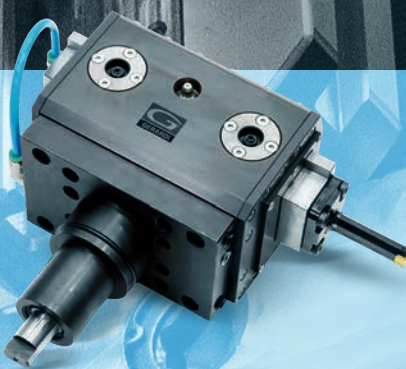

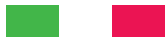

MORSA AUTOCENTRANTE CON GANASCE REVERSIBILI - IDEALE PER CENTRI A 5 ASSI

Art.650



Dot. standard: 1 Chiave a pipa, 1 Perno Calibrato, 2 tasselli di posizionamento e 2 tasselli per regolazione autocentrante

+ Arresto laterale magnetico Art. 370EM

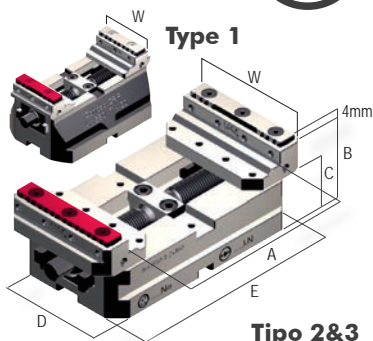

Tipo 2&3

Tipo	1 - 12kN			2 - 22kN				3 - 32kN				
Larghezza ganascia W	50			88				123				
Apertura massima A	54	94	134	96	136	176	216	133	183	233	283	333
Altezza morsa B	65			65				89				
Altezza corpo C	45			38				57				
Larghezza base D	79,9			89,9				124,9				
Lunghezza base E	80	120	160	120	160	200	240	160	210	260	310	360
Kg	1,9	2,7	3,4	3,6	4,4	5,2	5,8	9,1	10,9	12,8	14,8	17
Cod.	7.65.01080	7.65.01120	7.65.01160	7.65.02120	7.65.02160	7.65.02200	7.65.02240	7.65.03160	7.65.03210	7.65.03260	7.65.03310	7.65.03360
PREZZO LISTINO €	754	870	985	927	1.043	1.159	1.275	1.506	1.737	1.969	2.317	2.548
PREZZO OFFERTA €	649	749	849	749	849	949	1.049	1.249	1.349	1.449	1.749	1.949

INSERTI GRIP SPECIFICI PER QUALUNQUE MATERIALE E DUREZZA



Liscia + Ruvida
Materiali teneri e lavorazioni finali

Art.650S

7.65.0S

1000 2000 3000

~~€78~~ ~~€78~~ ~~€78~~

€58 €58 €58



Grip passo 1,5mm
Materiali di durezza normale

Art.650T G01

7.65.0T

1000/G01 2000/G01 3000/G01

~~€39~~ ~~€50~~ ~~€78~~

€29 €37 €58



Grip passo 2mm
Materiali di notevole durezza

Art.650T G02

7.65.0T

1000/G02 2000/G02 3000/G02

~~€39~~ ~~€50~~ ~~€78~~

€29 €37 €58



Grip passo 11mm
Materiali Teneri **Inclusi**

Art.650T G11

7.65.0T

1000/G11 2000/G11 3000/G11

~~€39~~ ~~€50~~ ~~€78~~

€29 €37 €58



Coda di rondine
Serraggio irreversibile ad Incastro

Art.650R

7.65.0R

1000 2000 3000

~~€34~~ ~~€34~~ ~~€34~~

€25 €25 €25



Fissa Centrale
Da serraggio singolo a doppio

Art.650X

7.65.0X

1000 2000 3000

~~€166~~ ~~€193~~ ~~€214~~

€122 €142 €158

RIALZI PER MORSE COMPACT GRIP

Art.651H

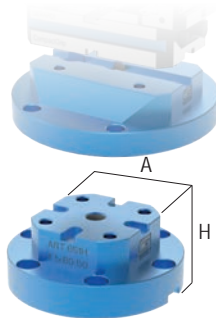

H	Tipo	1			2				3				
	Ingombro base A	80	120	160	120	160	200	240	160	210	260	310	360
50	Cod.	7.65.1H1080 /050	7.65.1H1120 /050	7.65.1H1160 /050	7.65.1H2120 /050	7.65.1H2160 /050	7.65.1H2200 /050	7.65.1H2240 /050	7.65.1H3160 /050	7.65.1H3210 /050	7.65.1H3260 /050	7.65.1H3310 /050	7.65.1H3360 /050
	PREZZO LISTINO €	401	477	570	570	570	570	705	660	660	1.016	1.053	1.218
	PREZZO OFFERTA €	350	400	450	450	500	550	600	650	650	950	1.000	1.100
75	Cod.	7.65.1H1080 /075	7.65.1H1120 /075	7.65.1H1160 /075	7.65.1H2120 /075	7.65.1H2160 /075	7.65.1H2200 /075	7.65.1H2240 /075	7.65.1H3160 /075	7.65.1H3210 /075	7.65.1H3260 /075	7.65.1H3310 /075	7.65.1H3360 /075
	PREZZO LISTINO €	412	501	601	601	601	601	750	704	704	1.073	1.112	1.287
	PREZZO OFFERTA €	350	400	500	500	550	600	600	650	700	950	1.000	1.100
100	Cod.	7.65.1H1080 /100	7.65.1H1120 /100	7.65.1H1160 /100	7.65.1H2120 /100	7.65.1H2160 /100	7.65.1H2200 /100	7.65.1H2240 /100	7.65.1H3160 /100	7.65.1H3210 /100	7.65.1H3260 /100	7.65.1H3310 /100	7.65.1H3360 /100
	PREZZO LISTINO €	424	523	634	634	634	634	796	746	746	1.133	1.171	1.357
	PREZZO OFFERTA €	350	400	500	500	550	600	650	650	700	950	1.000	1.100

SUPPORTO PIRAMIDALE SPECIFICO PER CENTRI DI LAVORO A 5 ASSI - MORSE INCLUSE

Dotazione standard: 12 Staffe di ancoraggio Art.298 CGR, 1 Golfare, 1 Perno di centraggio, Coppia di tasselli Art.297

MONTAGGIO & ALLINEAMENTO INCLUSO

Art.643H



Supporto piramidale in alluminio, consente di montare contemporaneamente 3 morse CompactGrip con o senza tavolette inclinate di 45° o 60° incrementando così lo spazio di lavoro e permettendo lavorazioni anche di più particolari contemporaneamente anche in punti normalmente difficili da raggiungere.

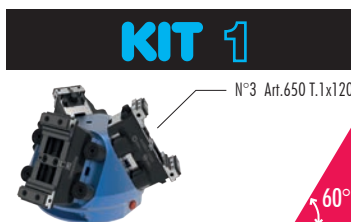

Tipo	1 (ø200)
Altezza	169,4 169,4
Cod.	7.64.3H100
P. LISTINO €	4.373
P. OFFERTA €	3.400

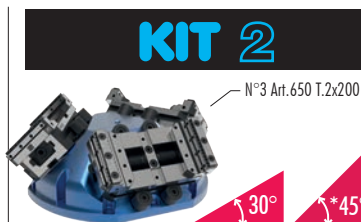

Tipo	2 (ø308)
Altezza	135,5
Cod.	7.64.3H200
P. LISTINO €	5.571
P. OFFERTA €	4.200

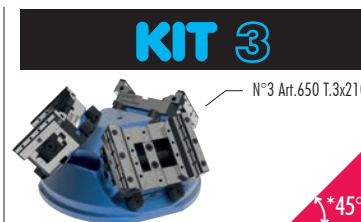

Tipo	3 (ø360)
Altezza	190,5
Cod.	7.64.3H300
P. LISTINO €	7.525
P. OFFERTA €	5.300

* Verificare volteggio tavola macchina

* Verificare volteggio tavola macchina



Scadenza il 31 Dicembre 2023

TAVOLE A CAMBIO RAPIDO MECCANICO PER MORSE COMPACT GRIP - IDEALI PER CENTRI A 5 ASSI

NON DISPONIBILI PER IL MERCATO TEDESCO E AUSTRIACO

Art.660

Tavola cambio rapido rettangolare

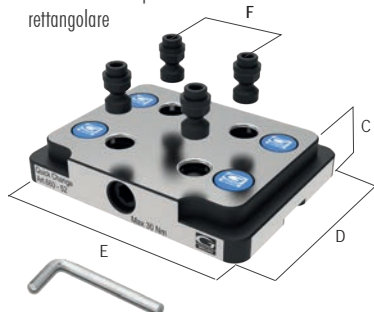

Dotazione standard: 4 Tiranti Art.660B

Tipo	1- 2	3
F	52	96
C	27	27
D	116	156
E	150	190
kg	3	5,2
Cod.	9.66.05200	9.66.09600
PREZZO LISTINO €	764	1.100
PREZZO OFFERTA €	649	949

Art.661

Tavola cambio rapido tonda

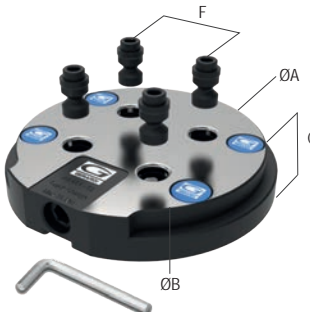

Dotazione standard: 4 Tiranti Art.660B

Type	1- 2	3
F	52	96
ØA	156	196
ØB	120	175
C	27	27
kg	3	5,2
Cod.	9.66.15200	9.66.19600
PREZZO LISTINO €	732	1.069
PREZZO OFFERTA €	649	949

Art.660S

Tavola cambio rapido rettangolare temprata con parte lavorabile senza fori

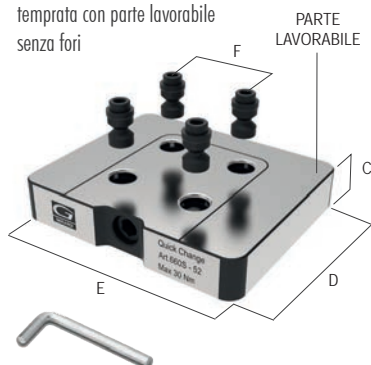

Dotazione standard: 4 Tiranti Art.660B

Tipo	1- 2	3
F	52	96
C	27	27
D	126	156
E	150	190
kg	3	5,2
Cod.	9.66.05520	9.66.09600
PREZZO LISTINO €	619	844
PREZZO OFFERTA €	549	749

Personalizzazione esclusa

Art.661S

Tavola cambio rapido tonda temprata con parte lavorabile senza fori

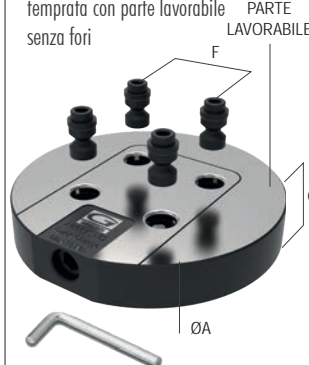

Disponibili modelli per qualsiasi tavola girevole o 4° asse

Dotazione standard: 4 Tiranti Art.660B

Tipo	1- 2	3	4
F	52	96	
ØA	156	196	250
C	27	27	24
kg	3,8	6	10
Cod.	9.66.15200	9.66.19600	9.66.15960-250
PREZZO LISTINO €	675	1.125	1.599
PREZZO OFFERTA €	549	749	1.650

Personalizzazione esclusa

Art.660R

Riduzione rettangolare

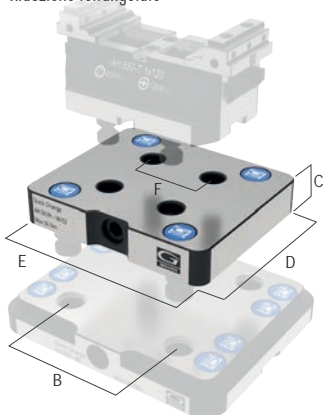

Dotazione standard: 4 Tiranti Art.660B

F	52
B	96
C	27
D	126
E	150
kg	3,75
Code	9.66.0R210
PREZZO LISTINO €	675
PREZZO OFFERTA €	549

Art.661R

Riduzione tonda

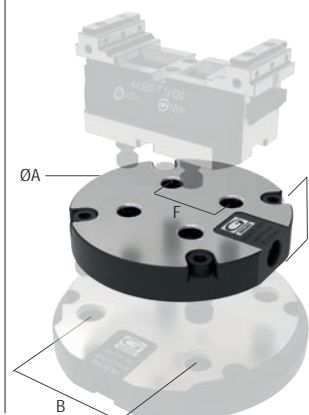

Dotazione standard: 4 Tiranti Art.660B

F	52
A	158
B	96
C	27
kg	3,75
Code	9.66.1R210
PREZZO LISTINO €	844
PREZZO OFFERTA €	549

Art.660B

Tiranti per tavola a cambio rapido



Tipo	1	2
Cod.	9.66.0B100	9.66.0B200
PREZZO LISTINO CAD. €	30	32

Art.661H

Rialzo base in alluminio per tavola cambio rapido, possibilità di montaggio con staffe o tramite Zero Point



Art.661S

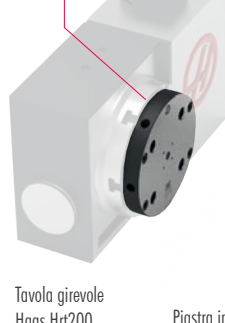

Tiranti Art.660B

Autocentrante

Tavola girevole Haas Hrt200

ESEMPIO di montaggio tavola a cambio rapido tonda per morse CompactGrip

Piastra interfaccia Art.62B

Morsa CompactGrip Art.650 T.3

GENIALE SISTEMA A PETTINE PER LA RAPIDA SOSTIZIONE DELLE PIASTRE GANASCE - IDEALE PER CENTRI VERTICALI

Art.1A

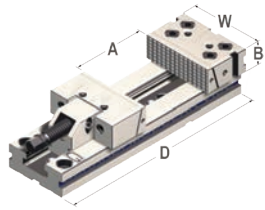

Morsa modulare di precisione serie StandardFLEX



Dot. standard: 1 Arresto laterale, 2 tasselli di posizionamento per cava 16mm, 2 Tappi, 1 Chiave a pipa, 1 Chiave a "T"

+ 4 Staffe Art.298



Larghezza ganascia	Tipo	2 - 25kN		3 - 30kN		4 - 30kN		5 - 40kN		
Apertura massima A		150	200	300	200	300	400	200	300	400
Larghezza ganascie W		121 mm	146 mm		171 mm		196 mm			
Altezza ganascie B		38	48		58		63			
Lunghezza base D		345	420	520	455	555	655	495	595	695
Cod.		1.1A.20000	1.1A.32000	1.1A.33000	1.1A.42000	1.1A.43000	1.1A.44000	1.1A.52000	1.1A.53000	1.1A.54000
PREZZO LISTINO €		898	1.079	1.245	1.372	1.509	1.646	1.792	2.145	2.506
PREZZO OFFERTA €		789	839	949	1.189	1.239	1.339	1.489	1.789	2.039

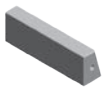

* Art.230B dolce



* Art.230C liscia



* Art.230E a Gradino



* Art.230F prismatica



* Art.138 a squadra sovrapponibile



* Art.150 prismatica sovrapponibile



* Art.212 mobile intermedia con doppio gradino



* Art.257 gruppo di serraggio a vite idraulica



Art.297 tasselli di posizionamento ≠ 16

RISPARMI IL
22%

* Solo se acquistate con la morsa

MORSE EXTRA LUNGHE

LE MORSE XL HANNO LA BASE MOLTO PIÙ LUNGA DELLE NORMALI MORSE STANDARD - IDEALI PER CENTRI VERTICALI

Art.21

(Serraggio Singolo)

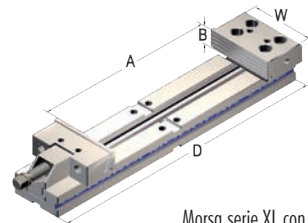

Morsa serie XL con dotazione standard



Dot. standard: 1 Arresto laterale, 2 tasselli di posizionamento per cava 16mm, 1 Chiave a pipa, 1 Chiave a "T"

+ 6 Staffe Art.298



Tipo	2 - 25kN	3 - 30kN		4 - 30kN		
Apertura massima A	320	360	460	500	600	700
Larghezza ganascie W	125 mm	150 mm		175mm		
Altezza ganascie B	40	50		60		
Lunghezza base D	520	580	680	766	866	966
Cod.	2.21.23200	2.21.33600	2.21.34600	2.21.45000	2.21.46000	2.21.47000
kg	17	32	35	52	56	61
PREZZO LISTINO €	1.113	1.383	1.532	1.774	1.932	2.096
PREZZO OFFERTA €	800	1.000	1.150	1.350	1.450	1.550



* Art.138 A squadra sovrapponibile



* Art.150 Prismatica sovrapponibile



* Art.217 Mobile Prismatica



* Art.313 Piastre magnetiche parallele piane



* Art.230S Piastra ganascia quadrettata



Art.297 Tasselli di posizionamento ≠ 16

RISPARMI IL
22%

* Solo se acquistate con la morsa

PARALLELE MAGNETICHE

WOOW

Art.414

Disponibili anche Parallele Magnetiche Universali

AMPIA GAMMA DI ALTEZZE DISPONIBILI A PAG.4.27 - LISTINO GENERALE W16

Grandezza - Tipo	1	2	3	4	5	6		
Art.310 6 COPPIE	6 coppie di parallele (Art.313-313R)							
	P. LISTINO €	276	348	420	498	552	636	
Prezzo Cad. se acquistate con set		P. OFFERTA €	46	58	70	83	92	106
Art.311 10 COPPIE	10 coppie di parallele (Art.313-313R)							
	P. LISTINO €	-	-	600	710	780	920	
Prezzo Cad. se acquistate con set		P. OFFERTA €	-	-	60	71	78	92

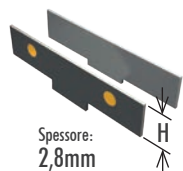

Spessore: 2,8mm



CENTRALINE CON COMANDO PNEUMATICO E CLINDRO A SINGOLO EFFETTO - IDEALE PER CENTRI VERTICALI

PER MORSE STANDARD & STANDARDFLEX ART.1 E ART.1A

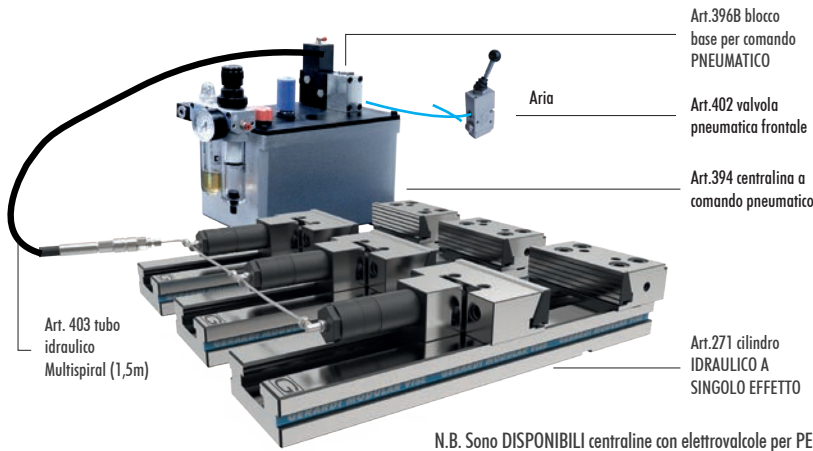

N.B. Sono DISPONIBILI centraline con elettrovalvole per PER CNC

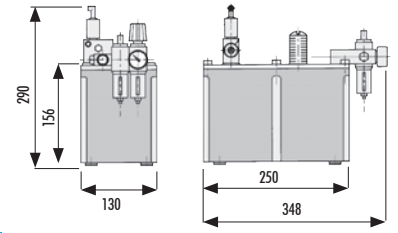

N°1 SERRAGGIO

Art.392

MORSA NON INCLUSA

Tipo	2	3	4	5
Corsa Pistone Art.271	26		40	
Cod.	4.39.22000	4.39.23000	4.39.24000	4.39.25000
LISTINO €	1.817	1.829	1.861	2.046
OFFERTA €	1.499	1.499	1.499	1.599

KIT DI SERRAGGIO SIMULTANEO DI PIÙ MORSE

***Art.405H** Tubo in acciaio zincato Ø6 (m1,0)
(Non compreso) Codice: 4.40.5H000

Art.392/2

(Art.271 - 394 - 402 - 403)

N°2 SERRAGGI SIMULTANEI
Art.392 + N°1 Art.271

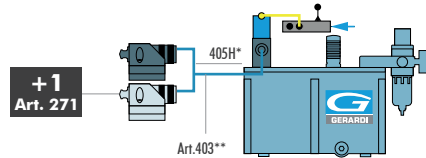

Tipo	2	3	4	5
Cod.	4.39.22002	4.39.23002	4.39.24002	4.39.25002
PREZZO LISTINO €	2.187	2.210	2.276	2.645
PREZZO OFFERTA €	1.799	1.799	1.799	2.099

Art.392/3

N°3 SERRAGGI SIMULTANEI
Art.392 + N°2 Art.271

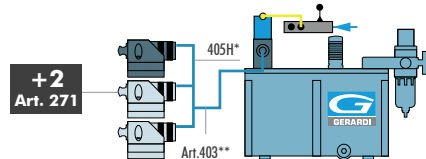

Tipo	2	3	4	5
Cod.	4.39.22003	4.39.23003	4.39.24003	4.39.25003
PREZZO LISTINO €	2.557	2.589	2.686	3.243
PREZZO OFFERTA €	2.099	2.099	2.099	2.499

Art.392/4

N°4 SERRAGGI SIMULTANEI
Art.392 + N°3 Art.271

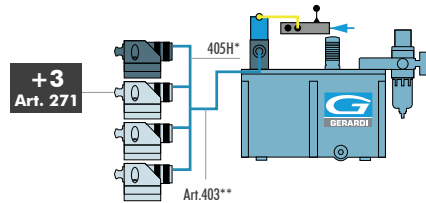

Tipo	2	3	4	5
Cod.	4.39.22004	4.39.23004	4.39.24004	4.39.25004
PREZZO LISTINO €	2.929	2.969	3.102	3.842
PREZZO OFFERTA €	2.399	2.399	2.399	2.999

KIT DI SERRAGGIO INDIPENDENTE DI PIÙ MORSE

***Art.403** Tubo idraulico Multispiral 760bar completo di attacco rapido Art. 270A (m 1,5) Codice: 4.40.30000
(Compresso)

Art.392A/2

(Art.271 - 394 - 402 - 403)

N°2 SERRAGGI INDIPENDENTI
Art.392 + N°1 Art.407B

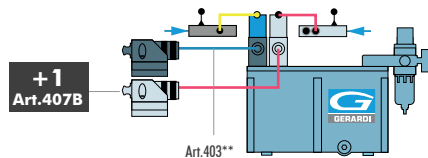

Tipo	2	3	4	5
Cod.	4.39.2A202	4.39.2A302	4.39.2A402	4.39.2A502
PREZZO LISTINO €	2.973	2.993	3.068	3.533
PREZZO OFFERTA €	2.399	2.399	2.399	2.799

Art.392A/3

N°3 SERRAGGI INDIPENDENTI
Art.392 + N°2 Art.407B

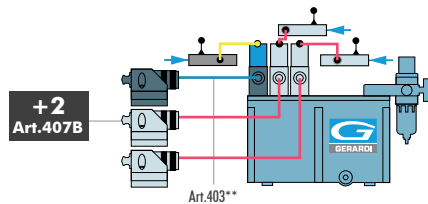

Tipo	2	3	4	5
Cod.	4.39.2A203	4.39.2A303	4.39.2A403	4.39.2A503
PREZZO LISTINO €	3.460	3.491	3.587	4.123
PREZZO OFFERTA €	2.799	2.799	2.799	3.299

Art.392A/4

N°4 SERRAGGI INDIPENDENTI
Art.392 + N°3 Art.407B

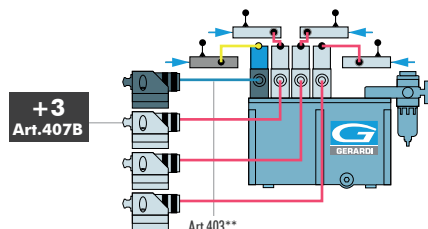

Tipo	2	3	4	5
Cod.	4.39.2A204	4.39.2A304	4.39.2A404	4.39.2A504
PREZZO LISTINO €	4.284	4.325	4.450	5.164
PREZZO OFFERTA €	3.599	3.599	3.599	4.199

PER SERRAGGI SINGOLI, DOPPI E AUTOCENTRANTI - IDEALI PER CENTRI VERTICALI E ED ORIZZONTALI



Tipo W		2 (94mm) - 25kN			3 (124mm) - 30kN		4 (144mm) - 30kN	
Art.855	Corpo Base 3 in 1	Altezza base A	90	90	90	100	100	120
Art.855A	Corpo Base Solo Autocentrante	Larghezza base B	95	95	95	125	125	145
		Lunghezza base C	400	500	600	500	600	600
		Cod.	5.85.52400	5.85.52500	5.85.52600	5.85.53500	5.85.53600	5.85.54600
		P. LISTINO €	1.325	1.794	1.981	1.721	2.380	2.192
		Cod.	5.85.5240A	5.85.5250A	5.85.5260A	5.85.5350A	5.85.5360A	5.85.5460A
		P. LISTINO €	1.404	1.890	2.052	1.809	2.484	2.268

COMPONI LA TUA MORSA CON LE CENTINAIA DI GANASCE DISPONIBILI

PER SERRAGGI DOPPI ED AUTOCENTRANTI

Art.860
Morsa doppia con ganasce zigrinate.

Tipo	2			3		4
Cod.	5.86.02400	5.86.02500	5.86.02600	5.86.03500	5.86.03600	5.86.04600
P. LISTINO €	1.741	2.214	2.399	2.198	2.855	2.823
P. OFFERTA €	1.400	1.800	1.950	1.800	2.300	2.300

Art.863
Morsa doppia con ganasce a gradino

Tipo	2			3		4
Cod.	5.86.32400	5.86.32500	5.86.32600	5.86.33500	5.86.33600	5.86.34600
P. LISTINO €	1.895	2.365	2.551	2.349	3.007	3.013
P. OFFERTA €	1.550	1.900	2.100	1.900	2.450	2.450

Art.865
Morsa doppia con ganasce a cambio rapido discendente (sistema a pettine)

Tipo	2			3		4
Cod.	5.86.52400	5.86.52500	5.86.52600	5.86.53500	5.86.53600	5.86.54600
P. LISTINO €	2.058	2.528	2.716	2.655	3.318	3.436
P. OFFERTA €	1.700	2.100	2.200	2.200	2.700	2.800

Art.866
Morsa doppia con ganasce oscillanti a gradino (3x5)

Tipo	2			3		4
Cod.	5.86.62400	5.86.62500	5.86.62600	5.86.63500	5.86.63600	5.86.64600
P. LISTINO €	2.176	2.648	2.833	2.680	3.338	3.292
P. OFFERTA €	1.800	2.200	2.300	2.200	2.700	2.700

Art.867
Morsa doppia con ganasce oscillanti con inserti regolabili

Tipo	2			3		4
Cod.	5.86.72400	5.86.72500	5.86.72600	5.86.73500	5.86.73600	5.86.74600
P. LISTINO €	2.541	2.959	3.197	3.078	3.737	3.761
P. OFFERTA €	1.999	2.328	2.516	2.423	2.941	2.960

*** SOLO AUTOCENTRANTI**

Corpo Base - Solo Autocentrante

Art.855A + 2 Ganasce Zigrinate **Art.810**

Tipo	2		3		4	
P. LISTINO €	1.599	2.072	2.257	2.038	2.695	2.603

* Per morsa SOLO autocentrante, distanziale Art.850T incluso nel prezzo

Corpo Base - Solo Autocentrante

Art.855A + 2 Ganasce a gradino **Art.810L**

Tipo	2		3		4	
P. LISTINO €	1.671	2.141	2.328	2.108	2.765	2.694

* Per morsa SOLO autocentrante, distanziale Art.850T incluso nel prezzo

Corpo Base - Solo Autocentrante

Art.855A + 2 Ganasce a cambio rapido discendente **Art.807**

Tipo	2		3		4	
P. LISTINO €	1.792	2.262	2.450	2.264	2.927	2.920

* Per morsa SOLO autocentrante, distanziale Art.850T incluso nel prezzo

Corpo Base - Solo Autocentrante

Art.855A + **Art.814** (n°2) + **Art.805V** (n°2)

Tipo	2		3		4	
P. LISTINO €	2.051	2.502	2.676	2.514	3.151	3.231

* Per morsa SOLO autocentrante, distanziale Art.850T incluso nel prezzo

Corpo Base - Solo Autocentrante

Art.855A + 2 Ganasce prismatiche **Art.810J**

Tipo	2		3		4	
P. LISTINO €	1.827	2.298	2.483	2.307	2.965	3.017

* Per morsa SOLO autocentrante, distanziale Art.850T incluso nel prezzo

IDEALE PER CENTRI A 5 ASSI

POSSONO SERRARE FINO A 19 PARTICOLARI DI DIMENSIONI DIVERSE - IDEALI PER CENTRI VERTICALI E ED ORIZZONTALI

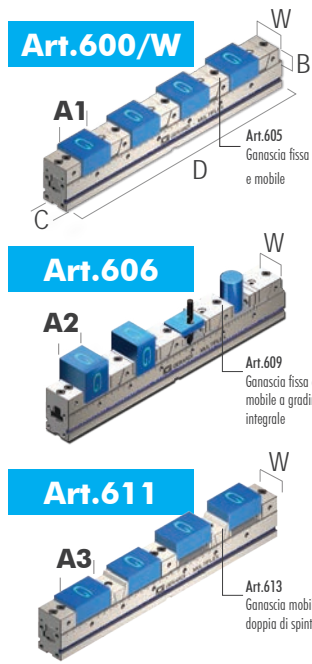

Dot. standard: Chiave a "T", 2 tasselli di posizionamento e 4 arresti laterali. Ogni morsa è predisposta per il serraggio di 4 pezzi.
+ COMPRESO : 6 Staffe Art.298 (* Modelli predisposti per serrare 3 particolari)

Tipo	Art.600 / Art.600W							Art.606				Art.611					
	mm	B	C ^{+0 -0.02}	D	W	A1 mm	Cod.	PREZZO LISTINO €	PREZZO OFFERTA €	A2 mm	Cod.	PREZZO LISTINO €	PREZZO OFFERTA €	A3 mm	Cod.	PREZZO LISTINO €	PREZZO OFFERTA €
1 20kN	32/25	50	300	49	4x8	6.60.01300		1.168	749	*3x19	6.60.61300	1.768	1.200	3x21	6.61.11300	1.768	1.200
	32/25	50	400	49	4x33	6.60.01400		1.269	849	4x23	6.60.61400	1.842	1.300	4x46	6.61.11400	1.842	1.300
	32/25	50	500	49	4x58	6.60.01500		1.383	949	4x48	6.60.61500	1.954	1.400	4x71	6.61.11500	1.954	1.400
	32/25	50	600	49	4x83	6.60.01600		1.507	1.049	4x73	6.60.61600	2.078	1.500	4x96	6.61.11600	2.078	1.500
	32/25	50	700	49	4x108	6.60.01700		1.685	1.149	4x97	6.60.61700	2.259	1.600	4x121	6.61.11700	2.259	1.600
2 30kN NEW	40	75	400	74	4x12	6.60.02400		1.520	1.099	*3x28	6.60.62400	2.200	1.550	4x34	6.61.12400	2.200	1.550
	40	75	500	74	4x37	6.60.02500		1.632	1.249	4x24	6.60.62500	2.316	1.650	4x59	6.61.12500	2.316	1.650
	40	75	600	74	4x62	6.60.02600		1.758	1.349	4x49	6.60.62600	2.443	1.750	4x84	6.61.12600	2.443	1.750
	40	75	700	74	4x87	6.60.02700		1.883	1.449	4x74	6.60.62700	2.569	1.850	4x109	6.61.12700	2.569	1.850
	40	75	800	74	4x112	6.60.02800		2.052	1.549	4x99	6.60.62800	2.749	1.950	4x134	6.61.12800	2.749	1.950
3 40kN	40	75	900	74	4x137	6.60.02900		2.234	1.749	4x124	6.60.62900	2.933	2.050	4x158,5	6.61.12900	2.933	2.050
	60	100	700	99	4x59	6.60.03700		2.178	1.649	4x44	6.60.63700	2.967	2.150	4x77	6.61.13700	2.967	2.150
	60	100	800	99	4x84	6.60.03800		2.357	1.749	4x69	6.60.63800	3.150	2.250	4x102	6.61.13800	3.150	2.250
	60	100	900	99	4x109	6.60.03900		2.542	1.949	4x94	6.60.63900	3.331	2.450	4x127	6.61.13900	3.331	2.450
60	100	1000	99	4x134	6.60.03100		2.785	2.149	4x119	6.60.63100	3.574	2.650	4x152	6.61.13100	3.574	2.650	

OFFERTA PIASTRE PARALLELE MAGNETICHE E RIPORTATE

Art.616
Coppia di piastre parallele magnetiche piane per Art.600

RISPARMI IL 27%

* Solo se acquistate con la morsa

Art.610E
Piastro parallelo riportata per Art.606

RISPARMI IL 23%

* Solo se acquistate con la morsa

MORSE AUTOCENTRANTI O ECCENTRICHE - IDEALI PER CENTRI DI LAVORO A 5 ASSI



Dot. Standard : 1 arresto laterale, 1 chiave a pipa, 1 coppia di tasselli di orientamento Art.297, 1 perno di centraggio Art.640P
! Possibile a richiesta 2 ganasce Art.645T anziché Art.645E

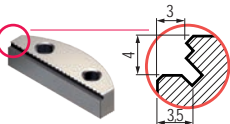

RISPARMI FINO AL
22%

Tipo	1	2	3x166	3x266
Cod.	6.64.01000	6.64.02000	7.64.03166	7.64.03266
PREZZO LISTINO €	1.720	2.115	2.460	2.578
P.OFFERTA €	1.049	1.249	2.039	2.124

Rialzo Semplice per morsa Art.640

Tipo	1	2	3x166	3x266
Cod.	7.64.1H100AL /100	7.64.1H200AL /100	7.64.1H3166AL /100	7.64.1H3266AL /100
PREZZO LISTINO €	621	731	746	1.133
P.OFFERTA €	400	450	600	900

Rialzo con zero point per morsa Art.640 per cambio rapido
 Dot Standard : 1 tirante Art.10S / 11S 1 tappo teflon con O-ring Art.9 - 1 perno di centraggio Art.640P - 1 spina di orientamento Art.79

Type	1	2	2
Altezza H	100	125	163
Code	9.63.10000	9.63.20000	9.64.20000
PREZZO LISTINO €	1.143	1.914	3.347
P.OFFERTA €	949	1.449	-

Tipo	1	2	3
Art.645B Ganascia Dolce	Cod. 6.64.5B100 P. LISTINO € 99 P. OFFERTA € 77	Cod. 6.64.5B200 P. LISTINO € 118 P. OFFERTA € 93	Cod. 6.64.5B300 P. LISTINO € 154 P. OFFERTA € 121
Art.645C Ganascia Liscia	Cod. 6.64.5C100 P. LISTINO € 99 P. OFFERTA € 77	Cod. 6.64.5C200 P. LISTINO € 118 P. OFFERTA € 93	Cod. 6.64.5C300 P. LISTINO € 154 P. OFFERTA € 121
Art.645D Ganascia zigrinata	Cod. 6.64.5D100 P. LISTINO € 99 P. OFFERTA € 77	Cod. 6.64.5D200 P. LISTINO € 118 P. OFFERTA € 93	Cod. 6.64.5D300 P. LISTINO € 154 P. OFFERTA € 121
Art.645E Ganascia a gradino	Cod. 6.64.5E100 P. LISTINO € 111 P. OFFERTA € 87	Cod. 6.64.5E200 P. LISTINO € 130 P. OFFERTA € 102	Cod. 6.64.5E300 P. LISTINO € 166 P. OFFERTA € 130
Art.645F Ganascia prismatica	Cod. 6.64.5F100 P. LISTINO € 125 P. OFFERTA € 98	Cod. 6.64.5F200 P. LISTINO € 141 P. OFFERTA € 111	Cod. 6.64.5F300 P. LISTINO € 179 P. OFFERTA € 141
Art.645T Ganascia Grip IN DOTAZIONE	Cod. 6.64.5T100 P. LISTINO € 125 P. OFFERTA € 98	Cod. 6.64.5T200 P. LISTINO € 141 P. OFFERTA € 111	Cod. 6.64.5T300 P. LISTINO € 179 P. OFFERTA € 141



FUSIONI IN GHISA MONOBLOCCO CON DOPPIO TRATTAMENTO DI DISTENSIONE - PER CENTRI ORIZZONTALI

STANDARD GIAPPONESE

Art.53B

Cod.	A	B	C	D	H	kg	LISTINO €	OFFERTA €
8.53.B00080	260	400	45	-	550	197	1.799	1.550
8.53.B00081	260	400	45	-	660	228	2.076	1.690
8.53.B00100	260	500	45	-	650	255	2.346	2.000
8.53.B00105	260	500	45	-	750	284	2.432	2.000
8.53.B00115	310	500	45	-	900	383	3.447	2.700
8.53.B00171	360	500	45	-	700	356	3.231	2.500
8.53.B00180	360	630	45	-	820	452	4.094	3.200
*8.53.B00211	510	630	45	-	860	61	5.687	3.550

*Solo per pallet a cave a "T"

Art.55B

Cod.	A	B	C	D	H	kg	LISTINO €	OFFERTA €
8.55.B00052	410	400	160	50	660	244	2.276	1.800
8.55.B00053	510	500	160	50	700	331	3.039	2.400
8.55.B00054	510	500	210	55	600	316	2.953	2.300
8.55.B00170	640	450	160	55	820	460	4.220	3.200
8.55.B00172	640	630	210	55	850	545	5.027	3.540
8.55.B00190	810	450	160	65	800	604	5.635	4.040

Art.57B

Cod.	A	B	C	E	H	kg	LISTINO €	OFFERTA €
8.57.B00100	210	500	50	80	750	157	1.632	1.500
8.57.B00110	280	500	50	80	850	235	2.024	1.900
8.57.B00120	240	500	50	110	850	218	1.951	1.750
8.57.B00130	310	500	50	150	850	269	2.348	2.000
8.57.B00140	310	630	50	150	950	327	2.657	2.350

Art.53B2 PLUS

Cod.	kg	LISTINO €	OFFERTA €
8.53.B20080	182	2.292	1.950
8.53.B20081	204	2.601	2.050
8.53.B20100	238	2.938	2.400
8.53.B20105	254	3.046	2.500
8.53.B20115	354	4.185	3.300
8.53.B20171	326	3.923	3.050
8.53.B20180	427	5.123	4.000
8.53.B20211	593	6.905	4.350

Art.55B2 PLUS

Cod.	kg	LISTINO €	OFFERTA €
8.55.B20052	206	2.763	2.150
8.55.B20053	303	3.690	2.900
8.55.B20054	301	3.585	2.800
8.55.B20170	433	5.124	4.000
8.55.B20172	520	6.104	4.300
8.55.B20190	782	6.842	4.900

Art.57B2 PLUS

Cod.	kg	LISTINO €	OFFERTA €
8.57.B20100	155	2.014	1.850
8.57.B20110	241	2.532	2.300
8.57.B20120	216	2.481	2.250
8.57.B20130	232	2.887	2.450
8.57.B20140	325	3.197	2.650

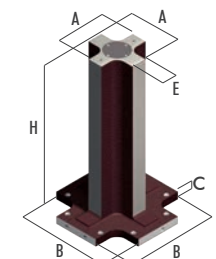
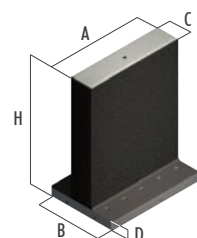
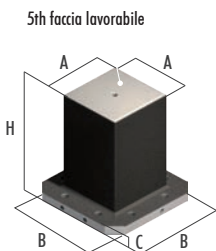

A Fusione in ghisa G30 monoblocco sgrassata con doppio trattamento di distensione. Pareti spessore 43-45 mm. Tolleranza +12 / -5 mm

B Fusione con base lavorata e raschietata per pallet a norme Giapponesi. Predisposizione della base di appoggio di n.4 fori Ø 20F7 e filetto M16 con interassi precisi, pronte per l'utilizzo dei ns. Zero Point, oppure per l'interfacciamento con altri pallet o piastre. Pronto da installare ed azzerare con assi macchina. Tolleranza +12 / -5 mm

C Cubo completamente finito con pareti spessore 38-40 mm circa. Tolleranza ± 0,02 mm

B2 PLUS Sovrametallo 1mm su ogni faccia. Pronto da installare e da azzerare con assi macchina.

E Cubo a reticolo con fori calibrati e filetti integrali. Tolleranza ± 0,02 mm

F Cubo a reticolo con bussole temprate 100 Cr6 e filetti riportati in acciaio inox. Tolleranza ± 0,02 mm

CUBI E SPALLE VERSIONE LEGGERE

Art.53B1

Cubo Leggero Base Finita

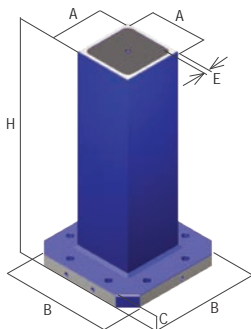

RISPARMI FINO AL **20%**



Art.55B1

Spalla Leggera Base Finita

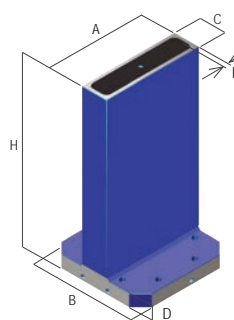

RISPARMI FINO AL **20%**



Dimensioni - Dimensions

A	B	C	E	H	kg	Cod.	PREZZO LISTINO €	OFFERTA SPECIALE €
210	400	45	25	750	167	8.53.B10055	1.799	1.500
260	400	45	25	850	229	8.53.B10085	2.169	1.800
260	500	45	25	750	234	8.53.B10105	2.367	1.950
360	500	45	30	900	400	8.53.B10182	3.352	2.700
360	630	45	30	950	468	8.53.B10185	4.014	3.250
460	630	45	35	950	634	8.53.B10205	5.010	4.050

E= Spessore pareti - Wall tickness

Dimensioni - Dimensions

A	B	C	D	E	H	kg	Cod.	PREZZO LISTINO €	OFFERTA SPECIALE €
400	400	110	55	25	750	193	8.55.B10045	2.049	1.700
400	400	160	55	25	850	239	8.55.B10050	2.274	1.900
500	500	160	55	25	750	277	8.55.B10053	2.676	2.200
500	500	210	55	30	900	402	8.55.B10085	3.428	2.800
630	630	210	55	30	950	553	8.55.B10172	4.614	3.700

E= Spessore pareti - Wall tickness



Scadenza il 31 Dicembre 2023

TEMPI DI ATTREZZAGGIO RIDOTTI DEL 90%, RIPETIBILITÀ ENTRO 0,005mm - IDEALI PER CENTRI VERTICALI, ORIZZONTALI E 5 ASSI

IL CLASSICO PNEUMATICO MULTIPLO

Dot. Standard: 1 tirante Art.11A
1 tappo teflon con O-Ring Art.9

L'ERMETICO PNEUMATICO SINGOLO



Tipo	1	2	3
Cod.	9.66.41000	9.66.42000	9.66.43000
kN	5,4	10	16
Doppio Effetto kN	NON DISPONIBILE		
LISTINO €	613	923	1.159
OFFERTA €	€499	€599	€999

Tipo	1	2	3
Cod.	9.66.51000	9.66.52000	9.66.53000
kN	5,4	10	16
Doppio Effetto kN	NON DISPONIBILE		
LISTINO €	494	801	1.043
OFFERTA €	€399	€499	€899

Tipo	1	2	3
Cod.	9.66.4S100	9.66.4S200	9.66.4S300
kN	5,4	10	16
Doppio Effetto kN	12,7	27	40
LISTINO €	710	1.006	1.159
OFFERTA €	€599	€699	€999

Tipo	1	2	3
Cod.	9.66.5S100	9.66.5S200	9.66.5S300
kN	5,4	10	16
Doppio Effetto kN	12,7	27	40
LISTINO €	592	887	1.043
OFFERTA €	€499	€599	€899

Forza di serraggio 5 ÷ 40 kN / Forza di arresto oltre a 60 kN / Sbloccaggio ad aria 6 ÷ 10 bar / Compensazione assiale e radiale grazie alla pinza elastica integrale / Doppio centraggio per tirante per massima rigidità / Pulizia ad aria / Solo per ZERO POINT SINGOLI (versione S): 4 CHIAVETTE e FUNZIONE DOPPIOEFFETTO (Aria+molle)

KIT SOVRATAVOLE INTERFACCIE CON ZERO POINT PNEUMATICI

KIT #1 e #2 POSIZIONAMENTO & FISSAGGIO INCLUSI

KIT #3 e #4 POSIZIONAMENTO E FISSAGGIO STANDARD INCLUSO E FISSAGGIO SPECIFICO **EXTRA***

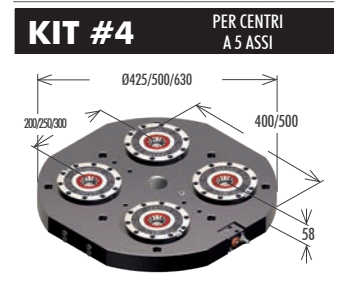
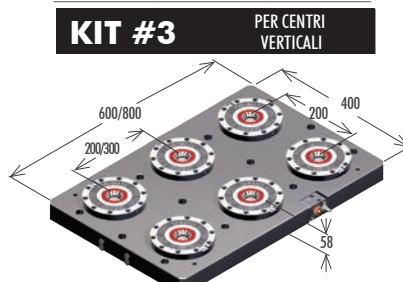
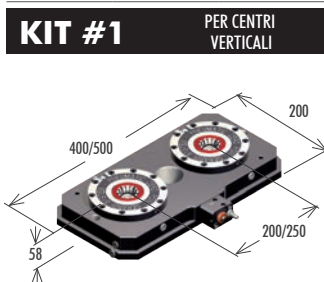

Art.81P PIASTRA BASE

	200x400	200x500
LISTINO €	2.644	2.711
OFFERTA €	1.749	1.849

Art.80P PIASTRA BASE

	400x400	500x500	630x630
LISTINO €	4.737	4.958	5.432
OFFERTA €	3.199	3.399	3.899

Art.81P PIASTRA BASE

	400x600	400x800
LISTINO €	6.830	7.118
OFFERTA €	4.499	4.799

Art.82P PIASTRA BASE TONDA

	Ø425	Ø500	Ø630
LISTINO €	4.956	4.936	5.508
OFFERTA €	3.399	3.499	3.999

PIASTRE D'INTERFACCIA PER PIASTRE ZERO POINT

*Richiedi la scheda tecnica

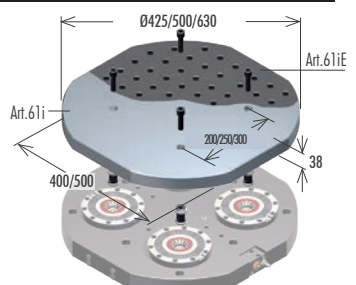
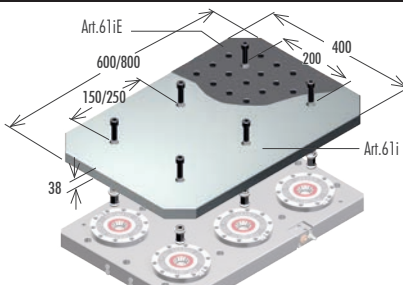
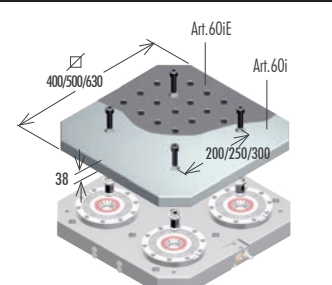
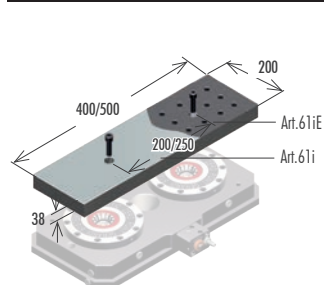

Art.61iE A RETICOLO INTEGRALE

	200x400	200x500
LISTINO €	1.101	1.213
OFFERTA €	649	749

Art.60iE A RETICOLO INTEGRALE

	400x400	500x500	630x630
LISTINO €	1.112	1.339	1.679
OFFERTA €	863	1.039	1.303

Art.61iE A RETICOLO INTEGRALE

	400x600	400x800
LISTINO €	2.022	2.875
OFFERTA €	1.440	2.048

Art.62iE A RETICOLO INTEGRALE

	Ø425	Ø500	Ø630
LISTINO €	1.192	1.361	1.588
OFFERTA €	924	1.056	1.232

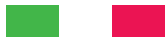

MORSA AUTOMATICA PNEUMATICA O IDRAULICA A DOPPIO EFFETTO - IDEALE PER CENTRI A 5 ASSI

Art.670

Modulo base morsa autocentrante idraulica o pneumatica



Dot. Standard: - 4x Viti calibrate (Art.83) - Perno di centraggio (Art.670P) - 2 Niplon o 2 raccordi Art.PN04 - Valvola di non ritorno (Art.PN16)

	2	3	4
Larghezza ganascia W	74	99	124
Apertura massima A	6,4	8,5	12
Apertura massima A1	88,9	130,2	162
Altezza morsa C+B	105	135	165
Altezza base C	80	105	130
Larghezza morsa D	106	166	206
Lunghezza ganascie E	52	78	96
Interasse fori di centraggio e fissaggio H	90	140	170
Pressione di esercizio	Max 10BAR		
Forza	7 kN	14,4 kN	16,9 kN
PNEUMATICO Art.670 - Cod.	7.67.OPN20	7.67.OPN30	7.67.OPN40
Pressione di esercizio	30BAR	30BAR	25 BAR
Forza	19 kN	37,5 kN	47 kN
IDRALICO Art.670 - Cod.	7.67.OID20	7.67.OID30	7.67.OID40
PREZZO LISTINO €	1.737	2.317	3.069
OFFERTA SPECIALE €	1.400	1.850	2.400

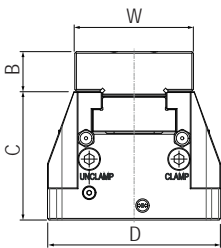
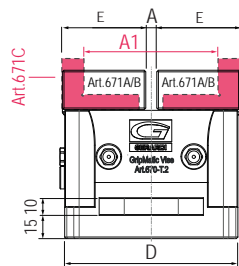
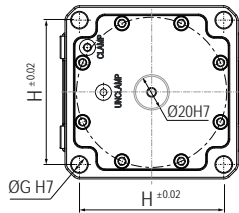

Art.671A
Ganascia lavorabile

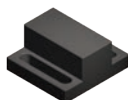

Art.671B
Ganascia lavorabile ridotta



Art.671C
Ganascia lavorabile ridotta



Art.243
Piastra ganascia piana rigata temprata



Art.245
Piastra ganascia piana liscia temprata



Art.247G
Piastra piana con inserti GRIP

PIASTRE D'INTERFACCIA PER MORSE GRIPMATIC - IDEALI PER CENTRI A 5 ASSI

Art.670CP

SEMI-AUTOMATICA

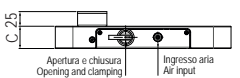

Piastra di interfaccia per morsa Grip Matic Art.670 PN semiautomatica con innesto aria tramite attacco rapido e apertura e chiusura gestiti manualmente tramite selettore

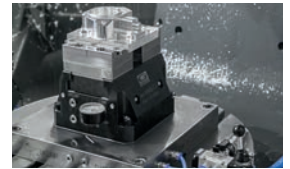

	2	3	4
Interasse fori A	90	140	170
Interasse fori B	90	140	170
Altezza piastra C	38	38	38
Interasse fori (Zero Point) D	200	200	200
Interasse fori (Zero Point) E	200	200	200
Interasse fori (Zero Point) F	250	250	250
Interasse fori (Zero Point) G	250	250	250
Pressione di esercizio	Max 10BAR		
Forza	7 kN	14,4 kN	16,9 kN
Cod.	7.67.OCP20	7.67.OCP30	7.67.OCP40
PREZZO LISTINO €	2.204	2.204	2.204

Art.670AP

AUTOMATICA

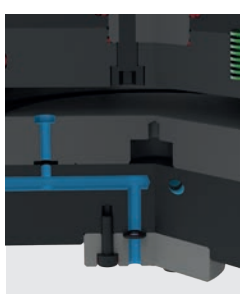
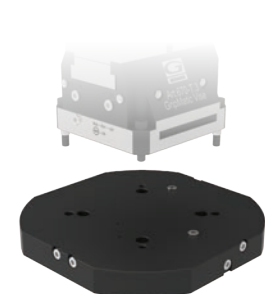

Piastra di interfaccia per morsa Grip Matic Art.670PN automatica con innesto aria tramite la tavola della macchina e gestibile direttamente dal CNC. Piastra completamente personalizzabile in base alle funzionalità della macchina utensile (comando di presenza pezzo e pulizia)

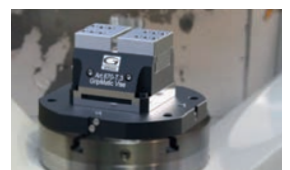

* Prezzo base minimo, PERSONALIZZAZIONE INCLUSA

PIASTRA PERSONALIZZABILE AL 100%

	2	3	4
Pressione di esercizio	Max 10BAR		
Forza	7 kN	14,4 kN	16,9 kN
ART.670 Pneumatico - Cod.	7.67.OAP20	7.67.OAP30	7.67.OAP40
PREZZO LISTINO €*	2.424	2.424	2.424



QUADRATE, RETTANGOLARI E TONDE - IDEALI PER CENTRI VERTICALI, ORIZZONTALI E 5 ASSI

SOVRATAVOLE QUADRATE IN ACCIAIO - IDEALI PER CENTRI ORIZZONTALI

Art. 60C

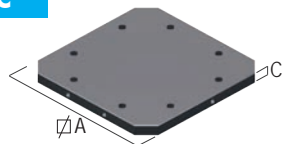

Piastra base per pallet liscia interfacciata. Piani rettificati

A	C	Kg	Cod.	PREZZO LISTINO €	OFFERTA SPECIALE €
400	38	45	8.60.C40404S	1.112	899
500	38	70	8.60.C50504S	1.339	1.099
630	38	115	8.60.C63634S	1.679	1.349
800	38	180	8.60.C80804S	2.200	1.799

Art. 60E

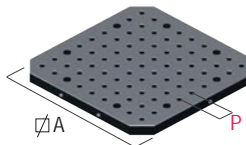

P = Passo 40 o 50mm

Piastra base a reticolo interfacciata per pallet con fori calibrati e filettati integrali

A	C	Kg	Cod.	P= 40		P= 50	
				PREZZO LISTINO €	OFFERTA SPECIALE €	PREZZO LISTINO €	OFFERTA SPECIALE €
400	48	55	8.60.E40400S	1.798	1.299	1.461	1.099
500	48	85	8.60.E50500S	2.359	1.699	1.910	1.399
630	48	135	8.60.E63630S	3.617	2.599	3.000	2.199
800	48	240	8.60.E80800S	5.616	4.099	3.932	2.900

Art. 60H

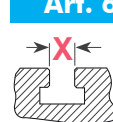

Piastra base interfacciata per pallet con cave parallele

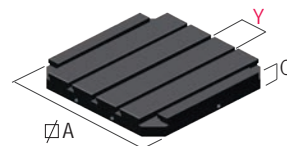

In caso di ordine specificare le quote X e Y

A	C	X*	Y	Kg	Cod.	PREZZO LISTINO €	OFFERTA SPECIALE €
400	73	16	100	80	8.60.H40400S	1.910	1.499
500	73	16	100	115	8.60.H50500S	2.696	2.099
630	73	16	100	205	8.60.H63630S	3.932	2.999
800	73	16	100	290	8.60.H80800S	4.493	3.499

* X = 16mm e 18mm standard. Altre misure a richiesta

SOVRATAVOLE RETTANGOLARI IN ACCIAIO - IDEALI PER CENTRI VERTICALI

Art. 61C

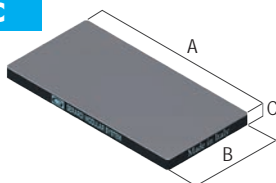

Piastra base liscia interfacciata. Piani rettificati

A	B	C	Kg	Cod.	PREZZO LISTINO €	OFFERTA SPECIALE €
600	400	38	71	8.61.C40600S	1.701	1.399
600	500	38	89	8.61.C50600S	1.928	1.549
800	400	38	95	8.61.C40800S	2.268	1.799
900	450	38	120	8.61.C45900S	2.835	2.299
1000	500	38	149	8.61.C50100S	3.402	2.699

Art. 61E

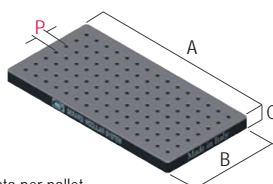

P = Passo 40 o 50mm

Piastra base a reticolo interfacciata per pallet con fori calibrati e filettati integrali

A	B	C	Kg	Cod.	PREZZO LISTINO €	OFFERTA SPECIALE €
600	400	38	90	8.61.E40600S	2.022	1.499
600	500	38	112	8.61.E50600S	2.472	1.799
800	400	38	119	8.61.E40800S	2.875	2.099
900	450	38	150	8.61.E45900S	3.370	2.499
1000	500	38	188	8.61.E50100S	3.932	2.899

Art. 61H

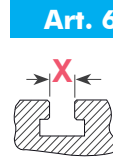

Piastra base interfacciata per pallet con cave parallele

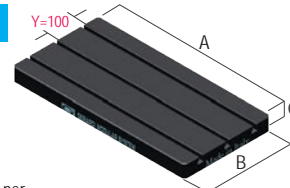

In caso di ordine specificare le quote X e Y

A	B	C	X*	Y	Kg	Cod.	PREZZO LISTINO €	OFFERTA SPECIALE €
600	400	73	16	122	8.61.H40600S	2.472	1.899	
600	500	73	16	155	8.61.H50600S	3.370	2.599	
800	400	73	16	165	8.61.H40800S	3.033	2.399	
900	450	73	16	212	8.61.H45900S	4.493	3.499	
1000	500	73	16	237	8.61.H50100S	5.055	3.899	

* X = 16mm e 18mm standard. Altre misure a richiesta

SOVRATAVOLE TONDE IN ACCIAIO - IDEALI PER CENTRI A 5 ASSI

Art. 62C

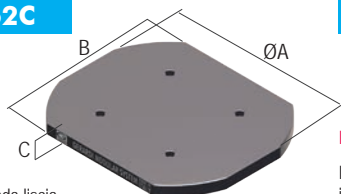

Piastra base tonda liscia interfacciata. Piani rettificati

A	B	C	Kg	Cod.	PREZZO LISTINO €	OFFERTA SPECIALE €
400	320	38	37	8.62.C4032S	1.192	949
500	400	38	58	8.62.C5040S	1.361	1.099
630	500	38	93	8.62.C6350S	1.588	1.299
800	630	38	-	8.62.C8063S	2.042	1.599

Art. 62E

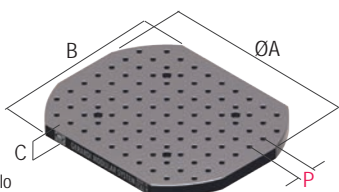

P = Passo 40 o 50mm

Piastra base tonda a reticolo interfacciata con fori calibrati e filettati integrali

A	B	C	Kg	Cod.	PREZZO LISTINO €	OFFERTA SPECIALE €
400	320	38	37	8.62.E4032S	1.461	1.099
500	400	38	58	8.62.E5040S	1.865	1.399
630	500	38	93	8.62.E6350S	2.494	1.799
800	630	38	150	8.62.E8063S	3.617	2.599

Art. 62H

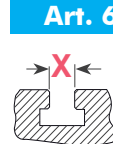

Piastra base tonda interfacciata con cave parallele

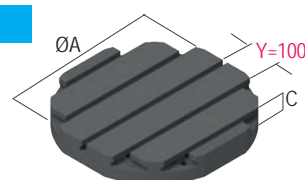

In caso di ordine specificare le quote X e Y

A	C	X*	Y	Kg	Cod.	PREZZO LISTINO €	OFFERTA SPECIALE €
400	73	16	-	8.62.H4032S	1.910	1.499	
500	73	16	-	8.62.H5040S	2.696	2.099	
630	73	16	-	8.62.H6350S	3.932	2.999	
800	73	16	-	8.62.H8063S	4.493	3.499	

* X = 16mm e 18mm standard. Altre misure a richiesta



RISPARMIA CON I KIT DI STATICI E BUSSOLE DI RIDUZIONI - A SCELTA TRA LA GAMMA A CATALOGO



SCANSIONA IL QR CODE E SCEGLI TRA L'INTERA GAMMA DI COSTRUTTORI DI STATICI PRESENTI A CATALOGO

DIN 69880

DMG MORI

Mazak

LOKUMA

BMT

Bolt Mounted Turret



Nakamura-Tome



Richiedi la password al tuo agente di zona

ESEMPIO KIT 1

3 PCS

ACQUISTANDO
3 PORTAUTENSILI STATICI

DMG MORI

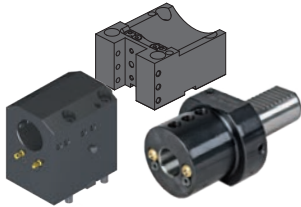

BMT

DIN 69880

RISPARMI IL
10%

ESEMPIO KIT 2

4 PCS

ACQUISTANDO
4 PORTAUTENSILI STATICI

DMG MORI

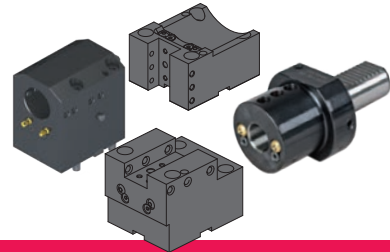

DIN 69880

BMT

DMG MORI

RISPARMI IL
15%

CAMBI RAPIDI MODULARI



NUOVI CAMBI RAPIDI UNIVERSALI 2.0 - COMPATIBILI CON TUTTE LE USCITE ER

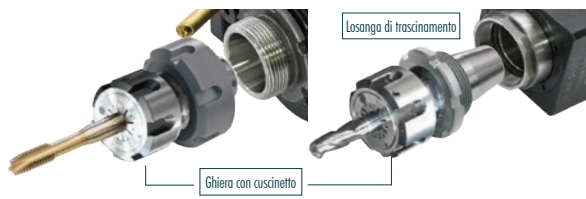

BREVETTO DEPOSITATO LOSANGA DI TRASCINAMENTO



PREZZO DI LISTINO 412€ CAD.

- Tempi di installazione ridotti e possibilità di presetting a bordo macchina
- Nuovi cambi rapidi modulari 2.0 a FORTE SERRAGGIO
- Portautensili modulari compatibili con tutte le uscite ER
- Prestazioni garantite e maggior rigidità sui motorizzati Gerardi grazie alla losanga di trascinamento (rimovibile) e alla ghiera con cuscinetto a sfera
- Adattabili a motorizzati con uscita refrigerante sia interna che esterna
- Si consiglia di non superare i 10.000Rpm utilizzando i cambi rapidi
- Compatibili anche con Preci-flex con ghiera interna

OFFERTE VALIDE FINO AD ESAURIMENTO SCORTE!

3 PCS

ACQUISTANDO UN
3 CAMBI RAPIDI
(GHIERA INTERNA O ESTERNA)



KIT1

RISPARMI IL
20%

4 PCS

ACQUISTANDO UN
4 CAMBI RAPIDI
(GHIERA INTERNA O ESTERNA)



KIT2

RISPARMI IL
25%

WOOW

ACQUISTA UN MOTORIZZATO CON USCITA ER25, ER32 o ER40
1 CAMBIO RAPIDO A SCELTA
(GHIERA INTERNA O ESTERNA)



KIT3

RISPARMI IL
50%

Sul Cambio Rapido



MOTORIZZATI PER TORNI CNC - L'ECCELLENZA TECNOLOGICA

BMT

Bolt Mounted Turret

COMPATIBILI CON TORNI

DOOSAN / HARDINGE / SAMSUNG / HWACHEON / HYUNDAI WUA / VICTOR / HAAS

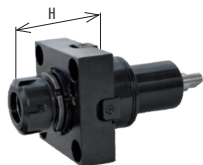

80
BAR

Assiali



80
BAR

Radiali



80
BAR

Orientabili

BMT 65 COMPATIBILI ANCHE CON TORNI HAAS!

BMT	Cod.	ER	H	Nm	Rpm	PREZZO LISTINO €	PREZZO SPECIALE €
45	99.DS.A03	25	Max 57,2	35	8000	1.802	839
	99.DS.A04	25	Max 57,2	35	8000	1.144	929
55	99.DS.A01	25	Max 57,2	40	8000	1.323	899
	99.DS.A02	25	Max 57,2	40	8000	1.206	979
65 HAAS READY!	99.DS.A41	32	Max 72,5	70	6000	1.236	1.049
	99.DS.A42	32	Max 72,5	70	6000	1.422	1.179
75	99.DS.A34	40	Max 90,2	100	6000	1.453	1.249
	99.DS.A35	40	Max 90,2	100	6000	1.669	1.399

BMT	Cod.	ER	H	Nm	Rpm	PREZZO LISTINO €	PREZZO SPECIALE €
45	99.DS.A07C	25	65	35	8000	1.768	1.499
	99.DS.A08C	25	65	35	8000	2.126	1.799
55	99.DS.A11C	25	70	40	8000	1.978	1.599
	99.DS.A12C	25	70	40	8000	2.337	1.899
65 HAAS READY!	99.DS.A51C	32	72	70	6000	2.077	1.699
	99.DS.A52C	32	72	70	6000	2.460	1.999
75	99.DS.A38C	40	60	100	6000	3.214	2.649
	99.DS.A39C	40	60	100	6000	3.857	3.099

BMT	Cod.	ER	H	Nm	Rpm	PREZZO LISTINO €	PREZZO SPECIALE €
45	99.DS.A16	20	65	15	8000	4.561	3.899
	99.DS.A17	20	65	15	8000	5.933	4.699
55	99.DS.A23	20	65	15	8000	4.561	3.899
	99.DS.A66	20	65	15	8000	5.933	4.699
65 HAAS READY!	99.DS.A64	25	75	25	6000	5.068	4.299
	99.DS.A65	25	75	25	6000	6.551	5.199
75	99.DS.A47	25	75	25	6000	5.068	4.299
	99.DS.A48	25	75	25	6000	6.551	5.199

Entrambe direzioni di rotazione disponibili

Tenone Maggiorato a Richiesta

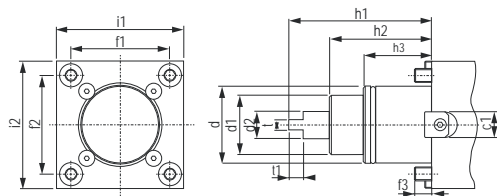

BMT	c1	d	d1	d2	f1	f2	f3	h1	h2	h3	i1	i2	t	t2	h4	N	ØM
45	15	Ø45	35	14	58	58	10	84	60	40	75	75	6	8,5	-	-	-
55	15	Ø55	40	16	64	64	14	104	75	30	85	85	8	8,5	9,5	8	29
65	18	Ø65	45	18	70	73	15	112	83	32	94	94	10	14	15	10	29
75	25	Ø75	55	23	90	90	15	110	80	43	112	112	14	15	-	-	-
85	25	Ø85	65	33,5	100	100	18	140	100	43	125	125	16	20	-	-	-

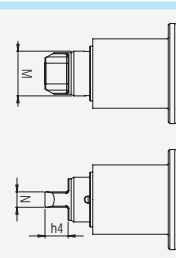

IN OFFERTA LE NUOVE GAMME DI MOTORIZZATI BIMU 2022

Mazak QTN3

QUICK TURN NEXUS QTN 300 / 350 / 400 / 450 - SQT 28 / 30 - 300

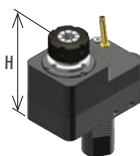

80
BAR

Disassati

Cod.	ER	H	Nm	Rpm	PREZZO LISTINO €	PREZZO SPECIALE €
99.MZ.A71	40	145	100	4000	3.223	3.000
99.MZ.A72	40	145	100	4000	3.525	3.200

LOKUMA VDI40

OKUMA CAPTAIN L370 M - ES L110 M - GENOS L300, L3000-E/M/Y (VDI40)
LB 300 MW - LB/LJ 300 MY - LB/LJ 300, 3000 M (VDI40)



80
BAR

Assiali

Cod.	ER	H	Nm	Rpm	PREZZO LISTINO €	PREZZO SPECIALE €
99.OK.A18	32	98,6	70	6000	1.890	1.499
99.OK.A23	32	98,6	70	6000	2.393	1.899

TAKISAWA BMT60

EX 380/310/508/510/708/710/910 - EX 2000 M/Y - TC 350 MC - TT 350 MC - NEX 108/110/908/910 - LA 200/250 M/Y - LA 250 YS (15 stations) - FX 800 - MX 800 - VTL 450 M - LX 2500 M/Y



80
BAR

Assiali

Cod.	ER	H	Nm	Rpm	PREZZO LISTINO €	PREZZO SPECIALE €
99.TK.A12	32	93	50	6000	1.455	1.149
99.TK.A13	32	93	50	6000	2.148	1.699

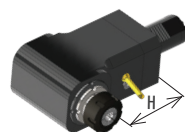

80
BAR

Radiali

Cod.	ER	H	Nm	Rpm	PREZZO LISTINO €	PREZZO SPECIALE €
99.MZ.A75	40	160	100	4000	3.324	3.100
99.MZ.A81	40	160	100	4000	3.828	3.500

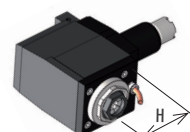

80
BAR

Radiali

Cod.	ER	H	Nm	Rpm	PREZZO LISTINO €	PREZZO SPECIALE €
99.OK.A19	32	70	60	6000	3.274	2.549
99.OK.A25	32	70	60	6000	4.030	3.149

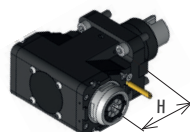

80
BAR

Radiali

Cod.	ER	H	Nm	Rpm	PREZZO LISTINO €	PREZZO SPECIALE €
99.TK.A02	32	90	50	6000	3.047	2.399
99.TK.A05	32	90	50	6000	3.235	2.549



Scadenza il 31 Dicembre 2023

MOTORIZZATI PER TORNI CNC - L'ECCELLENZA TECNOLOGICA

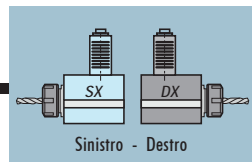

DIN 5480

VDI - DIN69880

* In caso di ordine specificare sempre se sinistro o destro



d1	Cod.	ER	H	Nm	Rpm	PREZZO LISTINO €	PREZZO SPECIALE €
30	99.ST.8003	25	66	32	6000	890	779
	99.ST.8011	25	66	32	6000	1.150	979
40	99.ST.8005	32	95	63	6000	1.113	999
	99.ST.8013	32	95	63	6000	1.455	1.229

Senso di rotazione uguale al mandrino

30	99.ST.8030	25	55	32	6000	1.869	1.599
	99.ST.8038	25	55	32	6000	2.151	1.829
40	99.ST.8033	32	100	63	6000	2.365	1.999
	99.ST.8041	32	100	63	6000	2.716	2.299

Senso di rotazione contrario al mandrino

DIN 5482

VDI - DIN69880

* In caso di ordine specificare sempre se sinistro o destro



d1	Cod.	ER	H	Nm	Rpm	PREZZO LISTINO €	PREZZO SPECIALE €
30	99.ST.8201	25	94	32	6000	839	779
	99.ST.8207	25	94	32	6000	1.127	979
40	99.ST.8203	32	115	63	5000	1.010	899
	99.ST.8208	32	115	63	5000	1.307	1.129

Senso di rotazione uguale al mandrino

30	99.ST.8217	25	55	32	6000	1.684	1.449
	99.ST.8223	25	55	32	6000	1.966	1.699
40	99.ST.8220	32	100	63	5000	2.017	1.699
	99.ST.8226	32	100	63	5000	2.359	1.999

Senso di rotazione contrario al mandrino



VDI - DIN69880

* In caso di ordine specificare sempre se sinistro o destro



d1	Cod.	ER	H	Nm	Rpm	PREZZO LISTINO €	PREZZO SPECIALE €
30	99.BF.0003	25	94	32	6000	868	779
	99.BF.0010	25	94	32	6000	1.158	979
40	99.BF.0005	32	117	63	5000	1.047	929
	99.BF.0011	32	115	63	5000	1.350	1.179

Senso di rotazione uguale al mandrino

30	99.BF.0021	25	55	32	6000	1.729	1.499
	99.BF.0027	25	55	32	6000	2.025	1.749
40	99.BF.0024	32	100	63	5000	2.077	1.749
	99.BF.0030	32	100	63	5000	2.433	2.049

Senso di rotazione contrario al mandrino

DIN 1809

VDI - DIN69880

* In caso di ordine specificare sempre se sinistro o destro



d1	Cod.	ER	H	Nm	Rpm	PREZZO LISTINO €	PREZZO SPECIALE €
30	99.DP.0903	25	94	32	6000	839	779
	99.DP.0910	25	94	32	6000	1.127	979
40	99.DP.0905	32	115	63	5000	1.010	879
	99.DP.0911	32	115	63	5000	1.307	1.129

Senso di rotazione uguale al mandrino

30	99.DP.0919	25	55	32	6000	1.684	1.449
	99.DP.0925	25	55	32	6000	1.966	1.699
40	99.DP.0922	32	100	63	5000	2.017	1.699
	99.DP.0928	32	100	63	5000	2.359	1.999

Senso di rotazione contrario al mandrino



NUOVA GAMMA BMT 55 - NON A CATALOGO CORPO MONOBLOCCO NICHELATO



d1	Cod.	Biglia Code	ER	H	Nm	Rpm	PREZZO SPECIALE €
55	99.BG.A01	10.57.88.00	25	70	47	6.000	699
	99.BG.A02	T.134-00061	32	70	47	6.000	699
	99.BG.A03	T.134-00071	32	70	47	6.000	949

Senso di rotazione uguale al mandrino

d1	Cod.	Biglia Code	ER	H	Nm	Rpm	PREZZO SPECIALE €
55	99.BG.A05	10.57.87.00	25	70	47	6.000	1.249
	99.BG.A06	T.134-00062	32	70	47	6.000	1.249
	99.BG.A07	T.134-00072	32	70	47	6.000	1.649
	99.BG.A08	T.134-00076	25	100	47	6.000	1.399
	99.BG.A09	T.134-00077	32	100	47	6.000	1.399
	99.BG.A10	T.134-00088	32	100	47	6.000	1.649

Senso di rotazione uguale al mandrino

d1	Cod.	Biglia Code	ER	H	Nm	Rpm	PREZZO SPECIALE €
55	99.BG.A15	T.134-00025	16	60	16	6.000	2.849
	99.BG.A16	T.134-00057	20	60	16	6.000	2.849

Senso di rotazione uguale al mandrino

DMG MORI

NLX 1500-2000-2500-3000 12 Posizioni NZX 12 Posizioni



Cod.	ER	H	Nm	Rpm	PREZZO LISTINO €	PREZZO SPECIALE €
99.MS.A59	32	86,2÷89,9	60	10.000	1.212	999
99.MS.A60	32	86,2÷89,9	60	10.000	1.793	1.429
99.MS.A62	40	88,5÷92	60	10.000	1.212	999
99.MS.A63	40	88,3÷92	60	10.000	1.793	1.429

99.MS.A72	32	Max 90	60	10.000	2.596	2.099
99.MS.A73	32	Max 90	60	10.000	2.985	2.349
99.MS.A76	40	90	60	10.000	2.596	2.099
99.MS.A77	40	90	60	10.000	2.985	2.349

Entrambe direzioni di rotazione disponibili*

NZ 1500-2000-3100- 3150-3200 16 Posizioni



Cod.	ER	H	Nm	Rpm	PREZZO LISTINO €	PREZZO SPECIALE €
99.MS.A101	25	80,6÷84,3	50	12.000	1.212	1.049
99.MS.A102	25	80,6÷84,3	50	12.000	1.793	1.479
99.MS.A103	32	85,5÷89,2	50	12.000	1.212	1.049
99.MS.A104	32	85,5÷89,2	50	12.000	1.793	1.479

Senso di rotazione uguale al mandrino

99.MS.A106	25	85	50	12.000	2.596	2.099
99.MS.A107	25	85	50	12.000	2.985	2.349
99.MS.A108	32	85	50	12.000	2.596	2.099
99.MS.A109	32	85	50	12.000	2.985	2.349

Senso di rotazione contrario al mandrino



Scadenza il 31 Dicembre 2023

MOTORIZZATI PER TORNI CNC - L'ECCELLENZA TECNOLOGICA

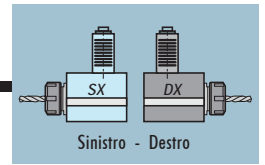

VDI 40

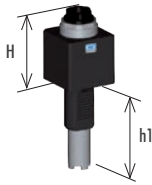

Cod.	ER	H	h1	Nm	Rpm	PREZZO LISTINO €	PREZZO SPECIALE €
99.HA.590082	32	75	117,5	63	6000	917	749
99.HA.590082B	32	75	117,5	63	6000	1.144	899
99.HA.590083	32	75	104,8	63	6000	917	749
99.HA.590083B	32	75	104,8	63	6000	1.144	899
99.HA.596352	32	75	130,25	63	6000	917	749
99.HA.596352B	32	75	130,25	63	6000	1.144	899

Senso di rotazione uguale al mandrino



* Presa di moto intercambiabile per le varie tipologie di torrette Haas

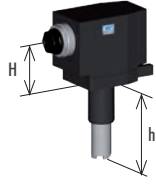

Cod.	ER	H	h1	Nm	Rpm	PREZZO LISTINO €	PREZZO SPECIALE €
99.HA.590084	32	75	117,5	63	6000	1.721	1.349
99.HA.590084B	32	75	117,5	63	6000	2.174	1.699
99.HA.590085	32	75	104,8	63	6000	1.721	1.349
99.HA.590085B	32	75	104,8	63	6000	2.174	1.699
99.HA.596353	32	75	130,25	63	6000	1.721	1.349
99.HA.596353B	32	75	130,25	63	6000	2.174	1.699

Senso di rotazione uguale al mandrino

Mazak

QTN2 12 Posizioni

QUICK TURN NEXUS QTN 200/250
SUPER QUADREX TURN SQT 15/18 - 200/250



Cod.	ER	H	Nm	Rpm	PREZZO LISTINO €	PREZZO SPECIALE €
99.MZ.A58	32	116,2 ÷ 120	80	6000	2.418	1.549
99.MZ.A59	32	116,2 ÷ 120	80	6000	2.922	2.100



99.MZ.A65	32	130	80	6000	2.619	1.649
99.MZ.A66	32	130	80	6000	2.821	1.949

Senso di rotazione contrario al mandrino

Mazak

SMART QTS1 - BMT68

QUICK TURN SMART QTS 100M / 200M
QT COMPACT 100M - 200M - 300M



Cod.	ER	H	Nm	Rpm	PREZZO LISTINO €	PREZZO SPECIALE €
99.MZ.A03	32	Max 70	60	6000	1.914	1.549
99.MZ.A06	32	Max 70	60	6000	2.317	1.949

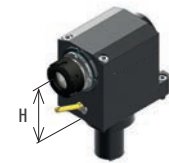

99.MZ.A09	32	80	60	6000	2.619	2.099
99.MZ.A10	32	80	60	6000	2.821	2.399

Senso di rotazione contrario al mandrino

Miyano

045: WT100 -TW1

054: WT100 -TW1



d1	Cod.	ER	H	Nm	Rpm	PREZZO LISTINO €	PREZZO SPECIALE €
45	99.MY.A02	25	53,9 ÷ 57,6	35	6000	828	749
	99.MY.A03	25	53,9 ÷ 57,6	35	6000	992	899
54	99.MY.A09	32	75,7 ÷ 79,4	60	6000	964	849
	99.MY.A10	32	75,7 ÷ 79,4	60	6000	1.106	949

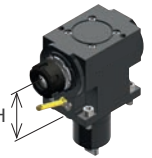

45	99.MY.A05	25	65	35	6000	1.462	1.249
	99.MY.A06	25	65	35	6000	1.757	1.649
54	99.MY.A11	32	75	60	6000	1.813	1.549
	99.MY.A12	32	75	60	6000	2.142	1.849

Senso di rotazione contrario al mandrino



BMT44 WT100 -TW1

BMT55 SUPER NTJ-NTJX / NTM 3 / TMC 18 / TW10 / SC150-250 / WT150-250 / WTW 150 / WTS 150 / WT100

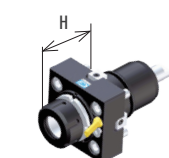

d1	Cod.	ER	H	Nm	Rpm	PREZZO LISTINO €	PREZZO SPECIALE €
45	99.NK.A40	25	Max 57,2	40	6000	918	799
	99.NK.A43	25	Max 57,2	40	6000	1.049	899
55	99.NK.A03	32	68,5 ÷ 72,2	63	6000	964	849
	99.NK.A04	32	68,5 ÷ 72,2	63	6000	1.485	1.299



45	99.NK.A50	25	60	40	6000	1.627	1.399
	99.NK.A53	25	60	40	6000	1.949	1.699
55	99.NK.A13	32	55	63	6000	1.813	1.549
	99.NK.A14	32	55	63	6000	2.445	2.099

LOKUMA

BMT60: SPACE TURN LB 200EX / LB 2500EX / LB3000EX / GENOS SERIES L300-MW / MULTUS U3000 / U40007 / LU3000EX M / MY

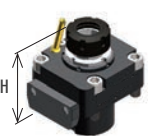
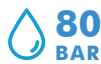

d1	Cod.	ER	H	Nm	Rpm	PREZZO LISTINO €	PREZZO SPECIALE €
60	99.OK.A80	32	Max 79	60	6000	1.637	1.299
	99.OK.A81	32	Max 79	60	6000	2.078	1.599

Senso di rotazione uguale al mandrino



60	99.OK.A82	32	70	60	6000	2.959	2.299
	99.OK.A83	32	70	60	6000	3.525	2.749

Senso di rotazione contrario al mandrino



BMT65: M06D / M06SD / M06SY / M08SD / M08SY



Cod.	ER	H	Nm	Rpm	PREZZO LISTINO €	PREZZO SPECIALE €
99.TS.A01	25	MAX 60	40	8000	1.512	1.199
99.TS.A02	25	MAX 60	40	8000	2.078	1.649



99.TS.A08	25	65	40	8000	2.455	1.949
99.TS.A09	25	65	40	8000	3.021	2.449



Scadenza il 31 Dicembre 2023

NOVITÀ!! DA OGGI ANCHE LE TESTE ANGOLARI CLASSIC LINE A PREZZO SPECIALE

DOTAZIONE STANDARD

Valigetta / Stop block / Ghiera ER / Chiavi di servizio / Tubetto di grasso / Libro istruzioni

Vai alla pagina di catalogo per approfondire



Ratio 1:1	Kg 5,4
Rpm 8.000	Ø 16
N 510	M 12
Nm 24	ER25 Ø1/16

CLASSIC LINE ATC

G90-16

Prezzo Listino ~~€3.598~~
Prezzo Speciale: **3.000**

DOTAZIONE STANDARD

Valigetta / Stop block / Ghiera ER / Chiavi di servizio / Tubetto di grasso / Libro istruzioni

Vai alla pagina di catalogo per approfondire



Ratio 1:1	Kg 11
Rpm 4.000	Ø 20
N 1.250	M 16
Nm 40	ER32 Ø2/20

CLASSIC LINE ATC

G90-20

Prezzo Listino ~~€3.804~~
Prezzo Speciale: **3.200**

AMPIA GAMMA DI MODELLI

quasi 200 modelli di teste classic line disponibili

MASSIMA RIGIDITÀ

grazie ad albero e cono integrali realizzati in un pezzo unico

CORPO ORIENTABILE A 360°

in acciaio temprato, massima rigidità e resistenza alla corrosione

CUSCINETTI ABEC 9

a contatto obliquo, precaricati e lubrificati con grasso a vita

INGRANAGGI GLEASON

garantiscono minor riscaldamento e rumorosità ed elevato numero di giri

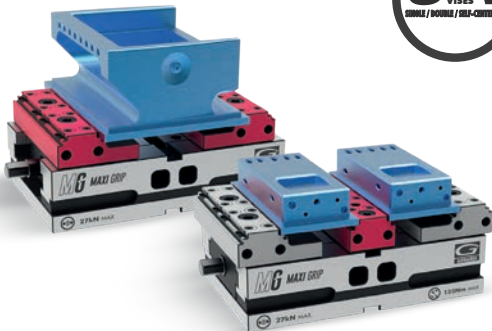

AUTOCENTRANTE
SINGOLA
DOPPIA

MORSE AUTOCENTRANTI

MAXI GRIP

SERRAGGIO AUTOCENTRANTE, DOPPIO O SINGOLO.
MASSIMA STABILITÀ DI SERRAGGIO E VERSATILITÀ DI UTILIZZO!

COMPATIBILITÀ

con il sistema Zero Point ed i sistemi di cambio pallet sul Mercato

INSERTI GRIP

intercambiabili e adatti al serraggio di differenti materiali

DOPPIO SERRAGGIO

contemporaneo di due particolari di dimensioni differenti

WOOW

RISPARMI IL **20%**

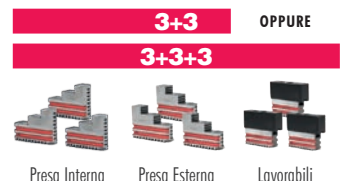

AUTOCENTRANTI DOPPIA GUIDA

DUODUX

PRECISIONE, RIGIDITÀ & STABILITÀ
ANCHE IN LAVORAZIONI GRAVOSE

VERSIONI SPECIALI

Oltre ai diametri della gamma standard

GRIFFE INTEGRALI

Garantisce elevata precisione e ripetibilità

DOPPIA GUIDA

Supporta maggiori carichi di lavoro